

KATALOG BRZI OHLAĐIVAČI I ZAMRZIVAČI

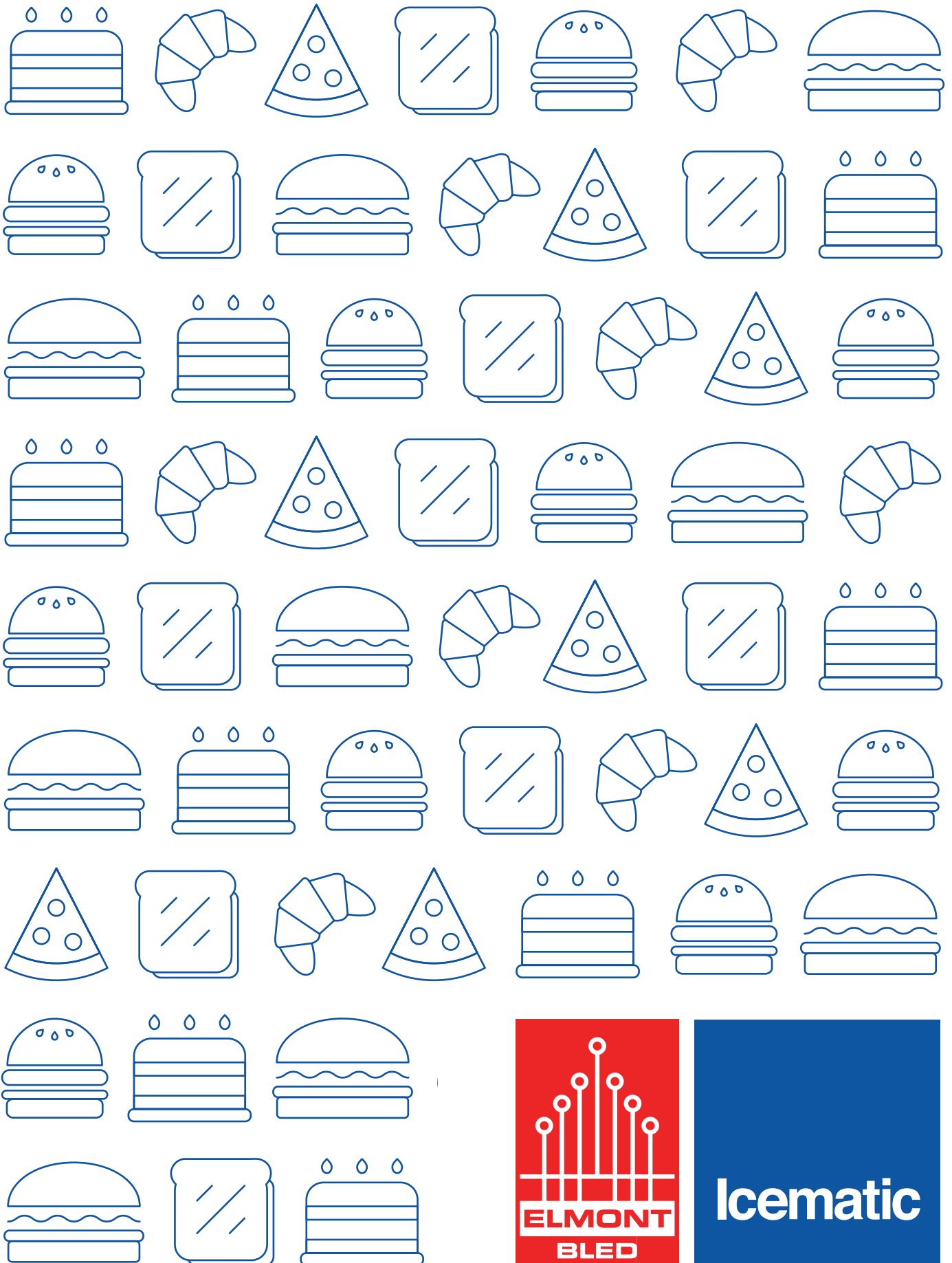

Index - Indeks

Blast Chillers and Freezers <i>Brzi ohlađivači i zamrzivači</i>	4
ST serija	8
BC serija	22
BT serija	32
BT serija (<i>Roll-in</i>)	40

BRZI OHLAĐIVAČI

The range - Asortiman

ST serija

Blast chillers at your fingertips.
Brzi ohlađivači na dodir prstiju.

BC serija

The advanced blast chiller: BC series by Icematic.
Napredni brzi ohlađivač: Icematic BC serija.

BT serija

The multifunction blast chillers.
Multifunkcionalni brzi ohlađivač.

BT Serija (Roll-in)

Quality and power in one machine.
Kvaliteta i snaga u jednom uređaju.

Functions - Funkcije

Blast Chilling

Icematic blast chillers allow the lowering of the temperature of freshly-cooked foods down to +3°C at the core. The speed of this process is essential: it allows to reduce the bacterial proliferation, that is particularly critical while food is at temperatures between +65°C and +10°C.

Brzo hlađenje

Icematic brzi ohlađivači omogućuju smanjenje svježih kuhanih jela na +3 °C u unutrašnjosti. Najvažnija je brzina ovog procesa: brzim hlađenjem sprečava se širenje bakterija, što je posebno kritično na temperaturama između +65 °C i +10 °C.

Blast Freezing

Icematic shock freezers, thanks to their powerful refrigeration systems with air temperature at -40°C, quickly lower the temperature at the core of foods down to -18°C, thus avoiding the macrocrystallization and granting a perfect and long lasting preservation of all the original qualities of foods.

Brzo zamrzavanje

Icematic brzi zamrzivači, zahvaljujući snažnom rashladnom sustavu s temperaturom zraka od -40 °C, brzo smanjuju temperaturu u unutrašnjosti jela na -18 °C te se tako sprečava makrokristalizacija i omogućuje se savršeno i dugotrajno očuvanje izvorne kvalitete jela.

Thanks to the longer shelf life of blast-chilled food, it is possible to plan the production better and prepare larger quantities of meals and semi-processed foods in advance, avoiding to repeat the same processes every day. All these operations always preserving the highest served food quality.

Zahvaljujući duljem roku trajanja brzo hlađenih jela moguće je bolje planirati i unaprijed pripremati veće količine jela i poluobrađenih namirnica tako da više nije potrebno svaki dan ponavljati isti proces. Sve te radnje pridonose očuvanju najveće kvalitete namirnica.

BRZI OHLAĐIVAČI

Applications - Primjene

Bakery

The continuous process of market's feedback, as an answer to the needs of bakers, has allowed, allows and will allow Icematic, to project, blast chillers and refrigerated cabinets with technological state of the art.

Pekarnica

Kontinuirano ispitivanje javnog mnijenja tržišta, kao odgovor na potrebe pekara, omogućio nam je, dalje nam omogućuje i uvijek će nam omogućivati da razvijamo brze ohlađivače i hladnjače s najmodernijom tehnologijom.

Gastronomy

The main advantage, besides the increased food safety (HACCP), is the reorganization of kitchen work by eliminating peaks and the useless everyday repetition of the same preparations, for a more efficient and effective environment.

Gastronomija

Glavna je prednost, osim veće sigurnosti prehrambenih proizvoda (HACCP), u reorganizaciji poslova u kuhinji tako da se eliminiraju stres i svakodnevno ponavljanje istih procesa za još učinkovitiju radnu okolinu.

Optionals - Opcije

Stainless steel grid <i>Okvir od nehrđajućeg čelika</i>	600 x 400 mm	
	600 x 800 mm	
	GN 1/1 325 x 530 mm	
Alluminium tray <i>Aluminijski pladanj</i>	br. 5 – GN 2/1	
	600 x 400 mm	
Stainless steel trolley for n° trays <i>Kolica od nehrđajućeg čelika za br. pladnjeva</i>	600 x 800 mm	
	br. 20 – 600 x 400 mm	
	br. 20 – 600 x 800 mm	
	br. 18 - GN 1/1	
	br. 18 - GN 2/1	

Pastry

A modern confectionery shop cannot avoid taking advantage of blast freezing techniques. The retarder proofers, blast chillers and refrigerated cabinets allow to organize and rationalize production in the laboratories, using the best modern technologies.

Peciva

U modernim slastičarnama nužna je uporaba uređaja za brzo zamrzavanje.

Komore za vrenje, brzi ohlađivači i hladnjače omogućuju bolju organizaciju i racionalizaciju proizvodnje u laboratorijima, koristeći se pritom najboljom modernom tehnologijom.

Ice Cream

The creaminess of ice-cream mainly depends on the presence of micro air-bubbles and micro ice-crystals. In order to maintain these special features, ice-cream must be shock frozen as soon as it leaves the whisker. Icematic blast freezers have a special shock freezing function for ice cream.

Sladoled

Kremasta konzistencija sladoleda uglavnom ovisi o mikromjehurićima zraka i mikrokristalima leda. Kako bi se postigla takva struktura, sladoled se mora brzo zamrznuti, čim izađe iz miksera. Icematic brzi zamrzivači raspoložu posebnom funkcijom za šok-zamrzavanje sladoleda.

Bacterial proliferation is very high when food has a temperature between +65°C and +10°C: around +37°C the number of bacteria doubles every 20 minutes. The use of Icematic blast chiller allows to reach the temperature of +3°C to the core of food in less than 90 minutes, crossing the range of hazardous temperatures quickly. This solution grants to minimize the quantity of bacteria in food after cooking, improving its quality, longevity and safety.

Bakterije se vrlo brzo šire u namirnicama na temperaturama između +65 °C i +10 °C: na temperaturi od +37 °C broj bakterija se udvostručuje svakih 20 minuta. Uporaba Icematic brzih ohlađivača omogućuje postizanje temperature od +3 °C u unutrašnjosti namirnice za manje od 90 minuta tako da se vrlo brzo prolazi kroz područje problematičnih temperatura. Ovim rješenjem sprečava se širenje bakterija nakon kuhanja, što dovodi do povećanja kvalitete, roka trajanja i sigurnosti hrane.

ST SERIJA

The machine - Uređaj

Blast chillers at your fingertips

Icematic is now introducing the new series ST range of blast chillers and blast freezers. These machines are designed to improve the quality and organization of work. Powerful, versatile, easy to use and reliable. These are the most important features of Icematic ST series blast chillers-freezers.

Brzi ohlađivači na dodir prstiju

Icematic vam predstavlja novu seriju ST iz asortimana brzih ohlađivača i zamrzivača. Ovi su uređaji dizajnirani za poboljšanje kvalitete i organizacije u radu. Snažni, raznovrsni, jednostavni za uporabu i pouzdani. To su najvažnija svojstva Icematic ST serije brzih ohlađivača-zamrzivača.

Control panel - Upravljačka ploča

Simple and intuitive to use, with ergonomic and evolved interface.
Jednostavna i intuitivna za uporabu, s ergonomičnim naprednim sučeljem.



Features - Značajke



- Soft touch control panel
- Fan blades in composite resin
- Core probe

- *Upravljačka ploča mekana na dodir*
- *Lopatice ventilatora od kompozitne smole*
- *Sonda za mjerenje temperature u unutrašnjosti*

The models - Modeli

ST 3 2/3
ST 3 1/1
ST 5 1/1
ST 5
ST 10
ST 15

ST 3 2/3

ST 3 2/3

ST 3 2/3 (with core probe - sa sondom za mjerenje temperature u unutrašnjosti)

Blast Chillers - Brzi ohlađivači

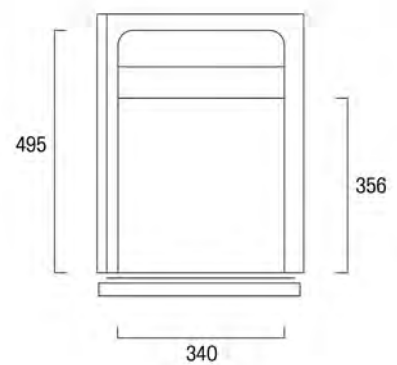
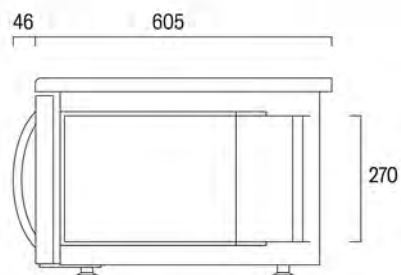
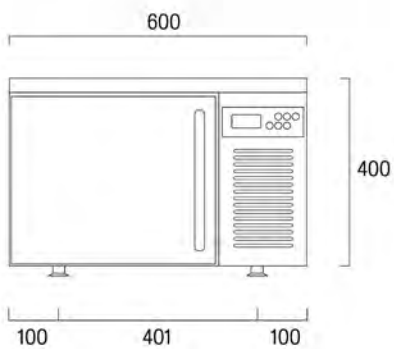

Capacity - Kapacitet	3 trays - 3 pladnja GN 2/3
Trays pitch - Prostor za pladnjeve	70 mm
Construction - Konstrukcija	Stainless steel - Nehrđajući čelik AISI 304
Voltage - Napon	220 – 240 V / 1 N / 50 Hz
Dimensions (WDH) - Dimenzije (Š x D x V)	600 x 605 (831) x 400 mm
Yield - Polje +90 °C → +3 °C	7 kg
Yield - Polje +90 °C → -18 °C	5 kg
Shipping data - Podaci za transport	Carton - Kutija 700 x 610 x 520 mm – 51 kg

Optionals - Opcije

Stainless steel grid GN 2/3
Okvir od nehrđajućeg čelika GN 2/3



ST 3 1/1

ST 3 1/1 (with core probe - sa sondom za mjerenje temperature u unutrašnjosti)

Blast Chillers - Brzi ohlađivači

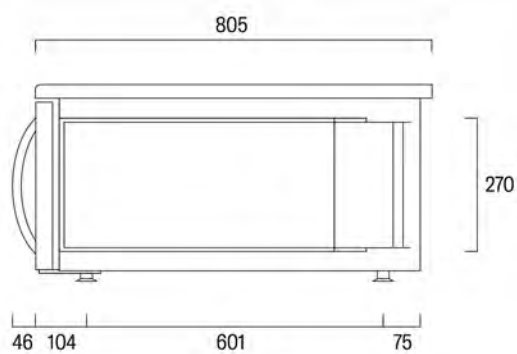
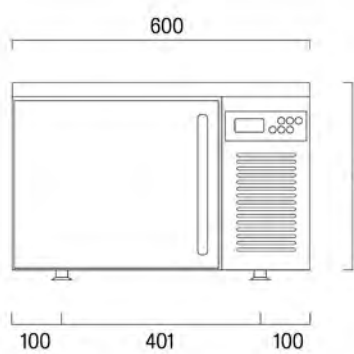

Capacity - Kapacitet	3 trays - 3 pladnja GN 1/1
Trays pitch - Prostor za pladnjeve	70 mm
Construction - Konstrukcija	Stainless steel - Nehrđajući čelik AISI 304
Voltage - Napon	220 – 240 V / 1 N / 50 Hz
Dimensions (WDH) - Dimenzije (Š x D x V)	600 x 805 x 400 mm
Yield - Polje +90 °C → +3 °C	7 kg
Yield - Polje +90 °C → -18 °C	5 kg
Shipping data - Podaci za transport	Carton - Kutija 900 x 700 x 600 mm – 62 kg

Optionals - Opcije

Stainless steel grid GN 1/1
Okvir od nehrđajućeg čelika GN 1/1



ST 5 1/1

ST 5 1/1

ST 5 1/1 (with core probe - sa sondom za mjerenje temperature u unutrašnjosti)



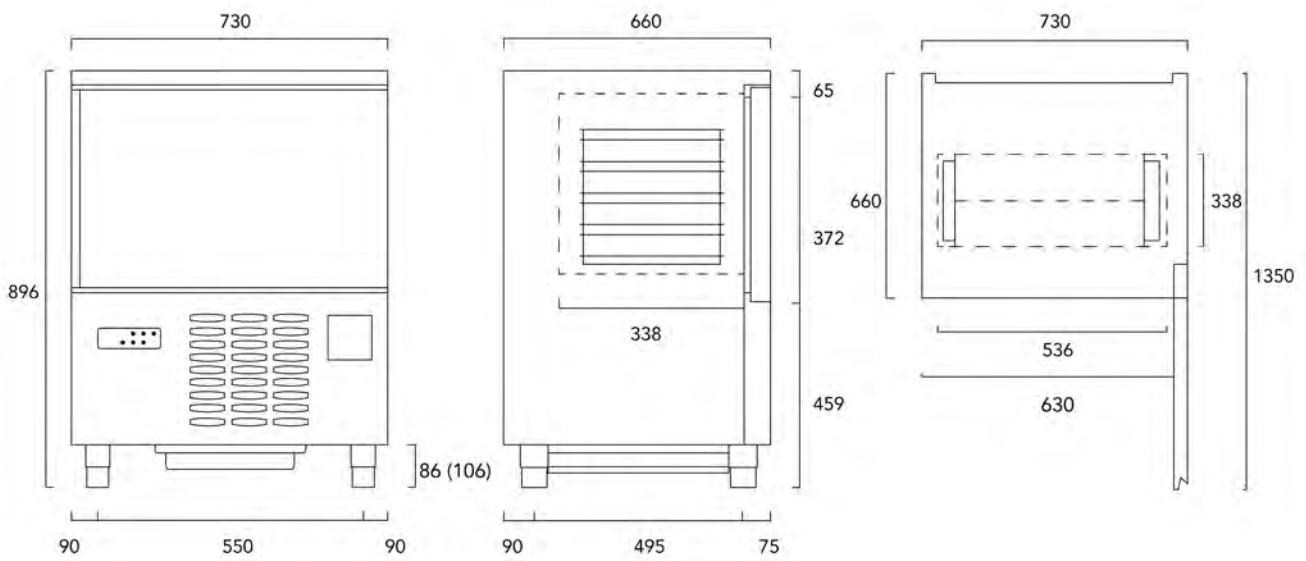

Blast Chillers - Brzi ohlađivači



Capacity - Kapacitet	5 trays - 5 pladnjeva GN 1/1
Trays pitch - Prostor za pladnjeve	68 mm
Construction - Konstrukcija	Stainless steel - Nehrđajući čelik AISI 304
Voltage - Napon	220 – 240 V / 1 N / 50 Hz
Dimensions (WDH) - Dimenzije (Š x D x V)	730 x 660 x 896 mm
Yield - Polje +90 °C > +3 °C	14 kg
Yield - Polje +90 °C > -18 °C	10 kg
Shipping data - Podaci za transport	Carton - Kutija 700 x 770 x 1050 mm – 117 kg
Notes - Napomene	Reversible door - Reverzibilna vrata Rear discharge 120 mm from floor Pražnjenje odostraga 120 mm od poda

Optionals - Opcije

■ OPCIONALNO ■ RETROFIT

<ul style="list-style-type: none"> ■ Castors kit ■ Komplet kotača 	
<ul style="list-style-type: none"> ■ Kit feet H 852 mm (only rear discharge version 70 mm from the floor) ■ Komplet nogu V 852 mm (samo za izvedbu s pražnjenjem odostraga, 70 mm od poda) 	
<ul style="list-style-type: none"> ■ Kit drain tray (only with core probe version) ■ Komplet pladnja za odvod (samo za verziju sa sondom) 	
<ul style="list-style-type: none"> ■ Water cooled condensing unit Kondenzacijska jedinica za hlađenu vodu 	

ST 5

ST 5

ST 5 P (only for pastry trays - samo za pladnjeve s pecivima)

Blast Chillers - Brzi ohlajivači

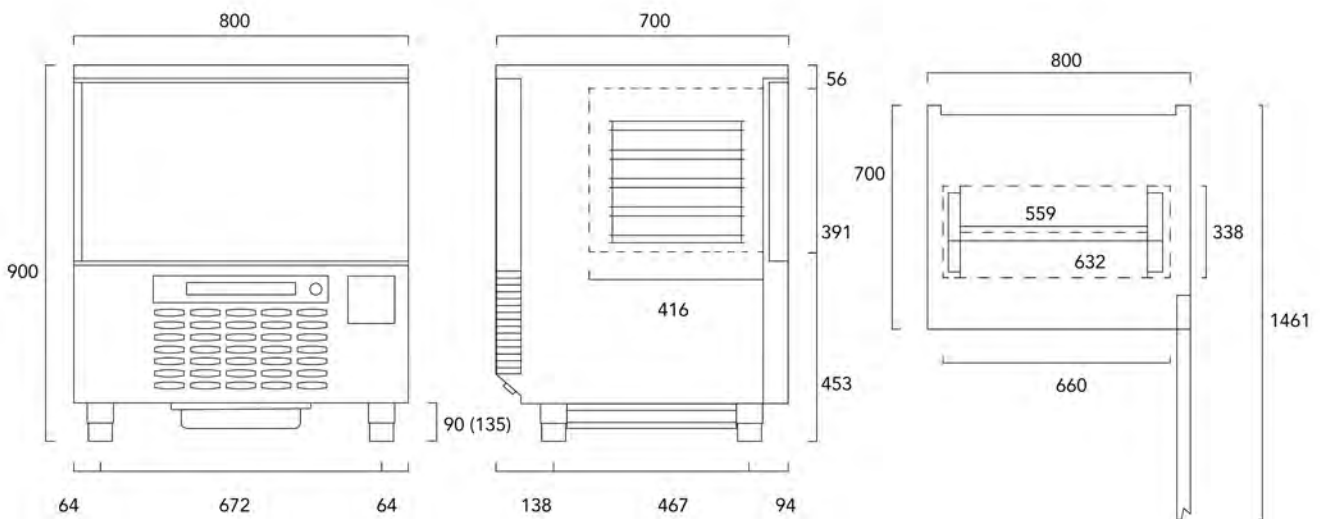







Capacity - Kapacitet	5 trays - 5 pladnjeva	600 x 400 mm
	5 trays - 5 pladnjeva	GN 1/1
Trays pitch - Prostor za pladnjeve		68 mm
Construction - Konstrukcija	Stainless steel - Nehrđajući čelik AISI 304	
Voltage - Napon	220 – 240 V / 1 N / 50 Hz	
Dimensions (WDH) - Dimenzije (Š x D x V)	800 x 700 x 900: 930 mm	
Yield - Polje +90 °C → +3 °C		18 kg
Yield - Polje +90 °C → -18 °C		10 kg
Shipping data - Podaci za transport	Carton - Kutija 850 x 740 x 1050 mm – 117 kg	
Notes - Napomene	Reversible door - Reverzibilna vrata	

Optionals - Opcije

■ OPCIONALNO

■ RETROFIT

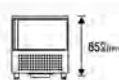
<ul style="list-style-type: none"> ■ Castors kit ■ Komplet kotača 	
<ul style="list-style-type: none"> ■ Ozone Sanitization Čišćenje ozonom 	
<ul style="list-style-type: none"> ■ USB Drive USB priključak 	
<ul style="list-style-type: none"> ■ Internal structure for pastry trays, variable pitch (10 mm) ■ Unutarnja struktura za pladnjeve s pecivom, varijabilni prostor (10 mm) 	
<ul style="list-style-type: none"> ■ N. 1 pair of stainless steel guides for variable pitch structure (10 mm) ■ Br. 1 par vodilica od nehrđajućeg čelika za varijabilnu strukturu prostora (10 mm) 	
<ul style="list-style-type: none"> ■ Water cooled condensing unit Kondenzacijska jedinica za hlađenu vodu 	
<ul style="list-style-type: none"> ■ Kit feet and special drain tray (H 852 mm) ■ Komplet nogu i specijalni pladanj za odvod (V 852 mm) 	

ST 10

ST 10

ST 10 P (only for pastry trays - *samo za pladnjeve s pecivima*)

Blast Chillers - Brzi ohlajivači

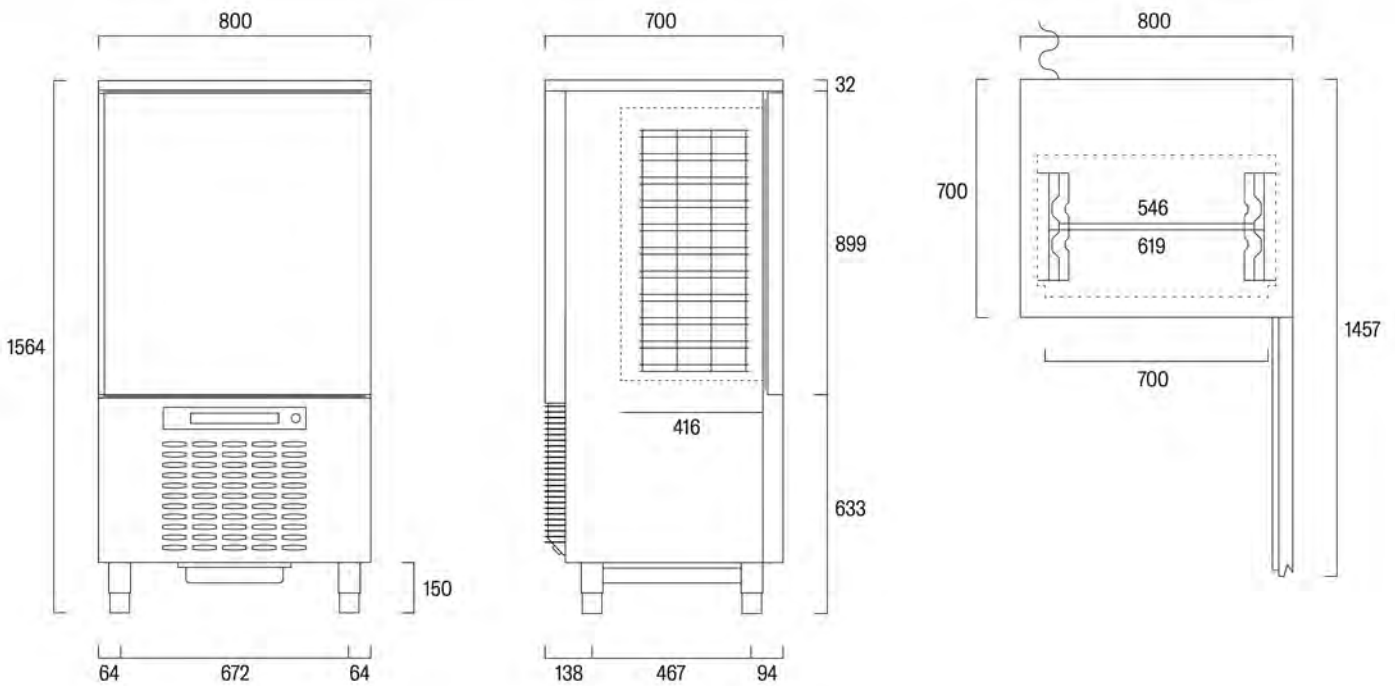

Capacity - Kapacitet	10 trays - 10 pladnjeva	600 x 400 mm
	10 trays - 10 pladnjeva	GN 1/1
Trays pitch - Prostor za pladnjeve		68 mm
Construction - Konstrukcija	Stainless steel - Nehrđajući čelik AISI 304	
Voltage - Napon	220 – 240 V / 1 N / 50 Hz	
Dimensions (WDH) - Dimenzije (Š x D x V)	800 x 700 x 1544: 1599 mm	
Yield - Polje +90 °C → +3 °C		32 kg
Yield - Polje +90 °C → -18°C		22 kg
Shipping data - Podaci za transport	Carton - Kutija 870 x 770 x 1710 mm – 156 kg	
Notes - Napomene	Reversible door - Reverzibilna vrata	

Optionals - Opcije

■ OPCIONALNO

■ RETROFIT

- Castors kit
- Komplet kotača



- Ozone Sanitization
- Čišćenje ozonom



- USB Drive
- USB priključak



- Internal structure for pastry trays, variable pitch (10 mm)
- Unutarnja struktura za pladnjeve s pecivom, varijabilni prostor (10 mm)



- N. 1 pair of stainless steel guides for variable pitch structure (10 mm)
- Br. 1 par vodilica od nehrđajućeg čelika za varijabilnu strukturu prostora (10 mm)



- Water cooled condensing unit
- Kondenzacijska jedinica za hlađenu vodu



ST 15

ST 15

ST 15 P (only for pastry trays - samo za pladnjeve s pecivima)

Blast Chillers - Brzi ohlađivači

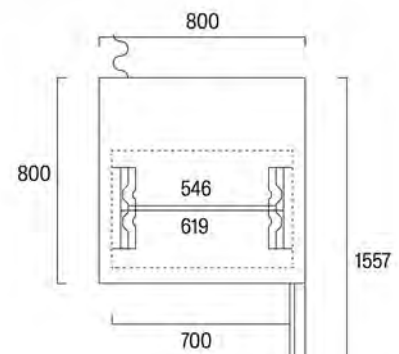
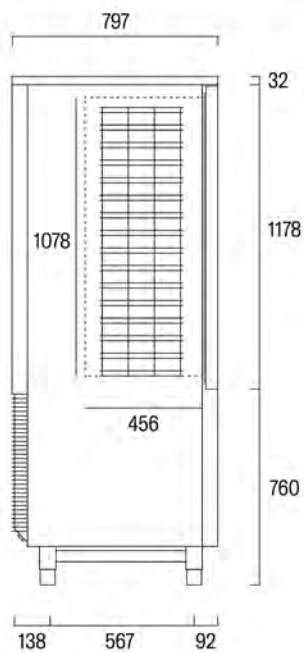
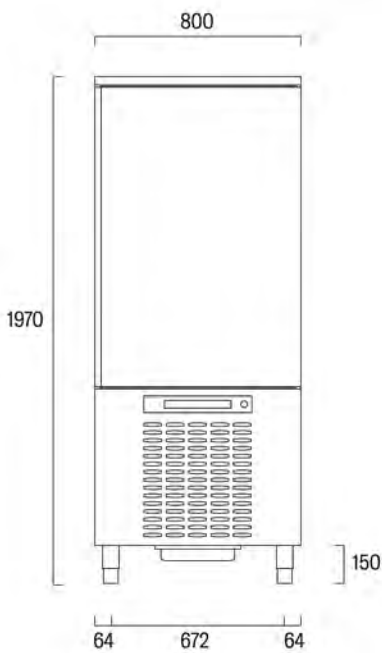





Capacity - Kapacitet	15 trays - 15 pladnjeva	600 x 400 mm
	15 trays - 15 pladnjeva	GN 1/1
Trays pitch - Prostor za pladnjeve		68 mm
Construction - Konstrukcija	Stainless steel - Nehrđajući čelik AISI 304	
Voltage - Napon	400 V / 1 N / 50 Hz	
Dimensions (WDH) - Dimenzije (Š x D x V)	800 x 797 x 1970: 2005 mm	
Yield - Polje +90 °C → +3 °C		40 kg
Yield - Polje +90 °C → -18 °C		28 kg
Shipping data - Podaci za transport	Carton - Kutija 870 x 920 x 2130 mm – 200 kg	
Notes - Napomene	Reversible door - Reverzibilna vrata	

Optionals - Opcije

■ OPCIONALNO

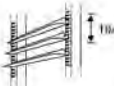
■ RETROFIT

<ul style="list-style-type: none"> ■ Castors kit ■ <i>Komplet kotača</i> 	
<ul style="list-style-type: none"> ■ Ozone Sanitization ■ <i>Čišćenje ozonom</i> 	
<ul style="list-style-type: none"> ■ USB Drive ■ <i>USB priključak</i> 	
<ul style="list-style-type: none"> ■ Internal structure for pastry trays, variable pitch (10 mm) ■ <i>Unutarnja struktura za pladnjeve s pecivom, varijabilni prostor (10 mm)</i> 	
<ul style="list-style-type: none"> ■ N. 1 pair of stainless steel guides for variable pitch structure (10 mm) ■ <i>Br. 1 par vodilica od nehrđajućeg čelika za varijabilnu strukturu prostora (10 mm)</i> 	
<ul style="list-style-type: none"> ■ Water cooled condensing unit ■ <i>Kondenzacijska jedinica za hlađenu vodu</i> 	

BC SERIJA

The machine - Uređaj

The advanced blast chiller: BlueChill Series by Icematic

This appliance includes the most evolved solutions in chilling and freezing for the best product quality, thawing and the specific function for ice cream production.

A user-friendly and dynamic Touch display allows the selection of different cycles modalities, the choice of the desired language and the possibility to save different programs.

Napredni brzi ohlađivač: Icematic BlueChill serija.

Ovaj uređaj uključuje najmodernija rješenja hlađenja i zamrzavanja za najbolju moguću kvalitetu proizvoda, funkciju otapanja i specijalnu funkciju za proizvodnju sladoleda.

Intuitivni i dinamički zaslon na dodir omogućuje odabir različitih ciklusa i željenih jezičnih postavki te mogućnost pohranjivanja različitih programa.

Control panel - Upravljačka ploča

Simple and intuitive to use, with Touch technology, enables easy viewing and programming of various functions.

Jednostavna i intuitivna uporaba, s Touch tehnologijom, omogućuje jednostavan pregled i programiranje različitih funkcija.



Features - Značajke

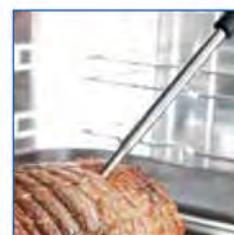

- Fan blades in composite resin
- USB Drive
- Deep-formed internal floor for easy cleaning
- Core probe
- Dual suitability trays rack
- Cabinet in stainless steel AISI 304
- Ice cream function

- *Lopatice ventilatora od kompozitne smole*
- *USB priključak*
- *Dubinski oblikovani unutarnji pod za jednostavno čišćenje*
- *Sonda za mjerenje temperature u unutrašnjosti*
- *Dvostruki ormar s pladnjevima*
- *Ormar od nehrđajućeg čelika AISI 304*
- *Funkcija za sladoled*

The models - Modeli

BC 5.20
 BC 10.35
 BC 15.40 - BC 15.65
 BC 15-2.70

BC 5

BC 5.20

BC 5.20 P (only for pastry trays - *samo za pladnjeve s pecivima*)

Blast Chillers - Brzi ohlajivači

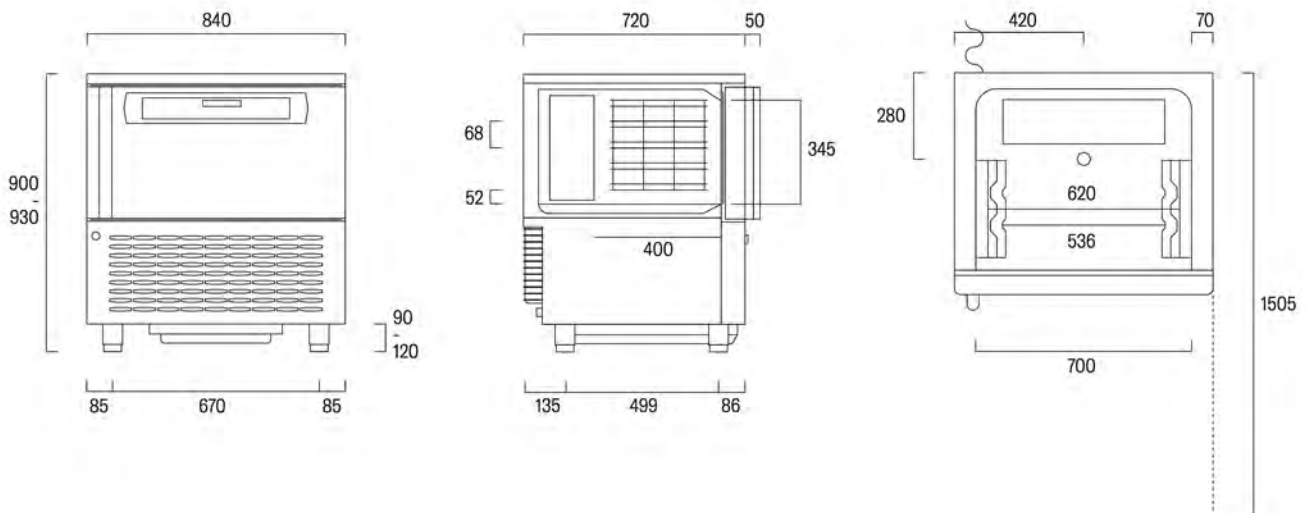





Capacity - Kapacitet	5 trays - 5 pladnjeva	600 x 400 mm
	5 trays - 5 pladnjeva	GN 1/1
Trays pitch - Prostor za pladnjeve		68 mm
Construction - Konstrukcija	Stainless steel - Nehrđajući čelik AISI 304	
Voltage - Napon	220 – 240 V / 1 N / 50 Hz	
Dimensions (WDH) - Dimenzije (Š x D x V)	840 x 720 (770) x 900: 930 mm	
Yield - Polje +90 °C → +3 °C		20 kg
Yield - Polje +90 °C → -18 °C		12 kg
Shipping data - Podaci za transport	Carton - Kutija 880 x 810 x 1070 mm – 126 kg	
Notes - Napomene	Reversible door - Reverzibilna vrata USB Drive included - USB priključak uključen	

Optionals - Opcije

■ OPCIONALNO

■ RETROFIT

<ul style="list-style-type: none"> ■ Castors kit ■ Komplet kotača 	
<ul style="list-style-type: none"> ■ Ozone Sanitization ■ Čišćenje ozonom 	
<ul style="list-style-type: none"> ■ Internal structure for pastry trays, variable pitch (10 mm) ■ Unutarnja struktura za pladnjeve s pecivom, varijabilni prostor (10 mm) 	
<ul style="list-style-type: none"> ■ N. 1 pair of stainless steel guides for variable pitch structure (10 mm) ■ Br. 1 par vodilica od nehrđajućeg čelika za varijabilnu strukturu prostora (10 mm) 	
<ul style="list-style-type: none"> ■ Water cooled condensing unit ■ Kondenzacijska jedinica za hlađenu vodu 	
<ul style="list-style-type: none"> ■ Kit feet and special drain tray (H 852 mm) ■ Komplet nogu i specijalni pladanj za odvod (V 852 mm) 	
<ul style="list-style-type: none"> ■ Seconde core probe ■ Druga sonda za mjerenje temperature u unutrašnjosti 	

BC 10

BC 10.35

BC 10.35 P (only for pastry trays - samo za pladnjeve s pecivima)

Blast Chillers - Brzi ohlađivači

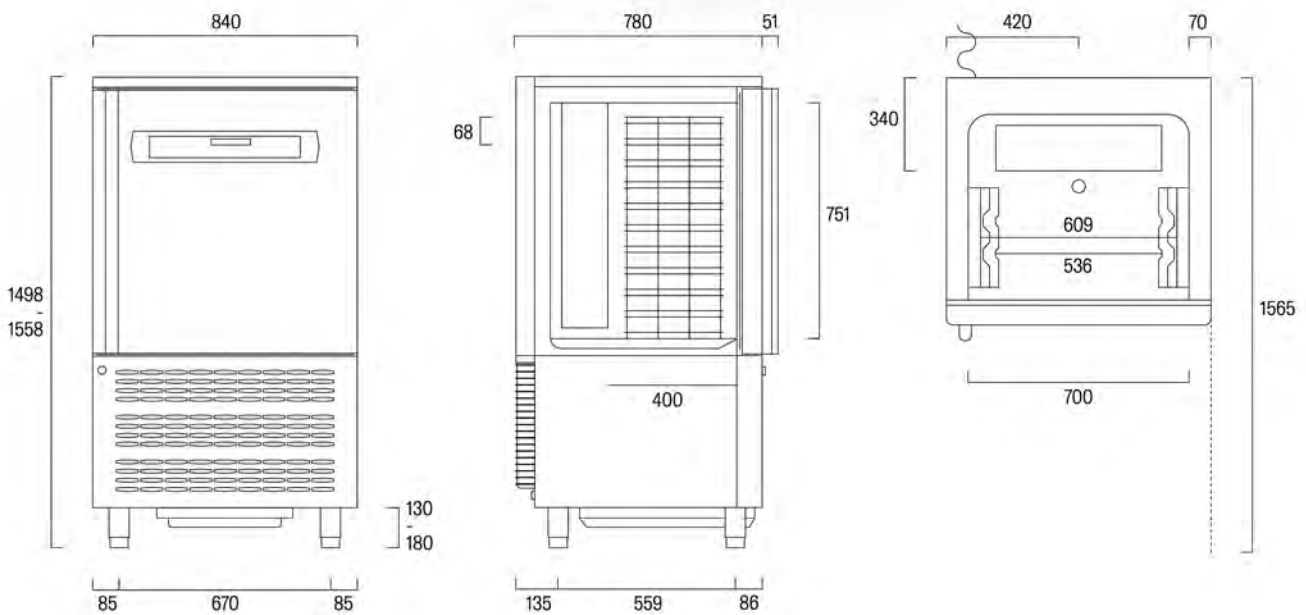

Capacity - Kapacitet	10 trays - 10 pladnjeva	600 x 400 mm
	10 trays - 10 pladnjeva	GN 1/1
Trays pitch - Prostor za pladnjeve		68 mm
Construction - Konstrukcija	Stainless steel - Nehrđajući čelik AISI 304	
Voltage - Napon	400 V / 3 N / 50 Hz	
Dimensions (WDH) - Dimenzije (Š x D x V)	840 x 780 (831) x 1498: 1558 mm	
Yield - Polje +90 °C → +3 °C	35 kg	
Yield - Polje +90 °C → -18 °C	25 kg	
Shipping data - Podaci za transport	Carton - Kutija 880 x 880 x 1660 mm – 190 kg	
Notes - Napomene	Reversible door - Reverzibilna vrata USB Drive included - USB priključak uključen	

Optionals - Opcije

■ OPCIONALNO

■ RETROFIT

- Castors kit
- Komplet kotača



- Ozone Sanitization
- Čišćenje ozonom



- Internal structure for pastry trays, variable pitch (10 mm)
- Unutarnja struktura za pladnjeve s pecivom, varijabilni prostor (10 mm)



- N. 1 pair of stainless steel guides for variable pitch structure (10 mm)
- Br. 1 par vodilica od nehrđajućeg čelika za varijabilnu strukturu prostora (10 mm)



- Water cooled condensing unit
- Kondenzacijska jedinica za hladenu vodu



- Seconde core probe
- Druga sonda za mjerenje temperature u unutrašnjosti



BC 15

BC 15.40

BC 15.40 P (only for pastry trays - samo za pladnjeve s pecivima)

BC 15.65

BC 15.65 P (only for pastry trays - samo za pladnjeve s pecivima)

Blast Chillers - Brzi ohlađivači

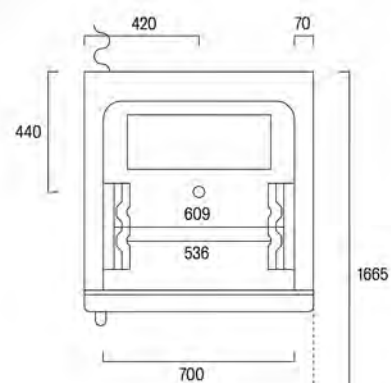
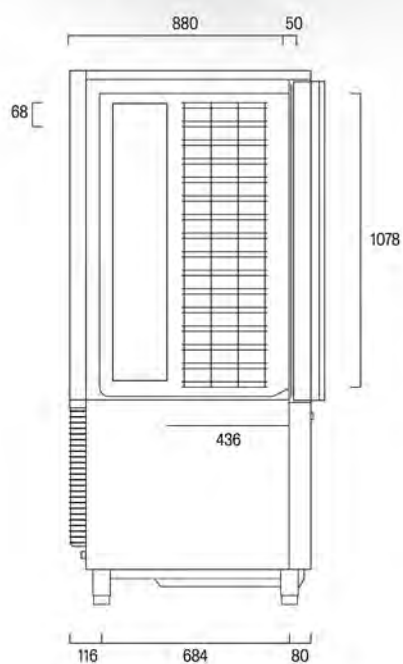
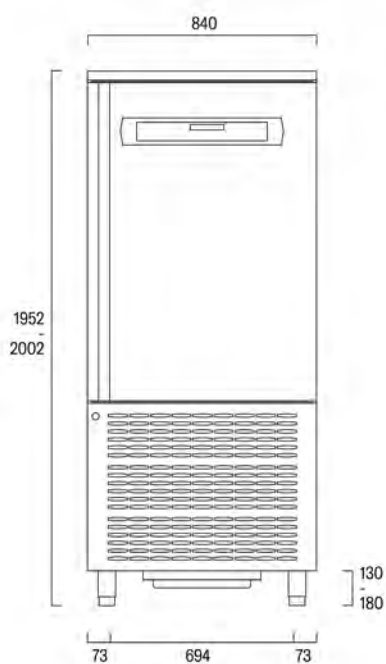







Capacity - Kapacitet	15 trays - 15 pladnjeva	600 x 400 mm
	15 trays - 15 pladnjeva	GN 1/1
Trays pitch - Prostor za pladnjeve		68 mm
Construction - Konstrukcija	Stainless steel - Nehrđajući čelik AISI 304	
Voltage - Napon	400 V / 3 N / 50 Hz	
Dimensions (WDH) - Dimenzije (Š x D x V)	840 x 880 (930) x 1952: 2002 mm	
Yield - Polje +90 °C → +3 °C	BC 15.40	40 kg
	BC 15.65	65 kg
Yield - Polje +90 °C → -18 °C	BC 15.40	30 kg
	BC 15.65	50 kg
Shipping data - Podaci za transport	BC 15.40	Carton - Kutija 900 x 980 x 2160 mm – 260 kg
	BC 15.65	Carton - Kutija 900 x 980 x 2160 mm – 283 kg
Notes - Napomene	Reversible door - Reverzibilna vrata USB Drive included - USB priključak uključen	

Optionals - Opcije

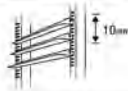
■ OPCIONALNO

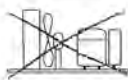
■ RETROFIT

<ul style="list-style-type: none"> ■ Castors kit ■ Komplet kotača 		
<ul style="list-style-type: none"> ■ Ozone Sanitization Čišćenje ozonom 		
<ul style="list-style-type: none"> ■ Internal structure for pastry trays, variable pitch (10 mm) ■ Unutarnja struktura za pladnjeve s pecivom, varijabilni prostor (10 mm) 		
<ul style="list-style-type: none"> ■ N. 1 pair of stainless steel guides for variable pitch structure (10 mm) ■ Br. 1 par vodilica od nehrđajućeg čelika za varijabilnu strukturu prostora (10 mm) 		
<ul style="list-style-type: none"> ■ Water cooled condensing unit Kondenzacijska jedinica za hlađenu vodu 	BC 15.40 BC 15.65	
<ul style="list-style-type: none"> ■ Remote condensing unit (installation kit 10 m) Daljinska kondenzacijska jedinica (instalacijski komplet 10 m) 	BC 15.65	
<ul style="list-style-type: none"> ■ Seconde core probe Druga sonda za mjerenje temperature u unutrašnjosti 		

BC 15-2

BC 15-2.70

BC 15-2.70 P (only for pastry trays - samo za pladnjeve s pecivima)

Blast Chillers - Brzi ohlađivači

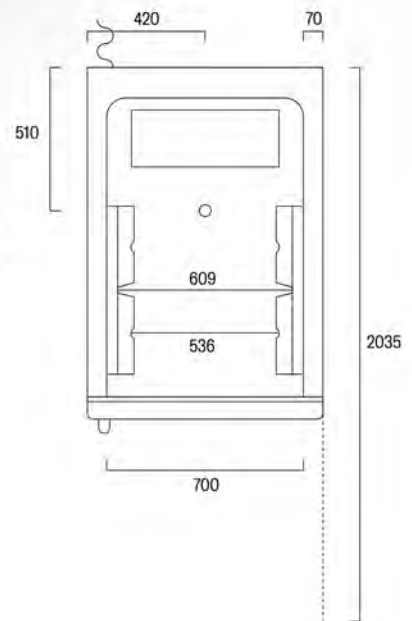
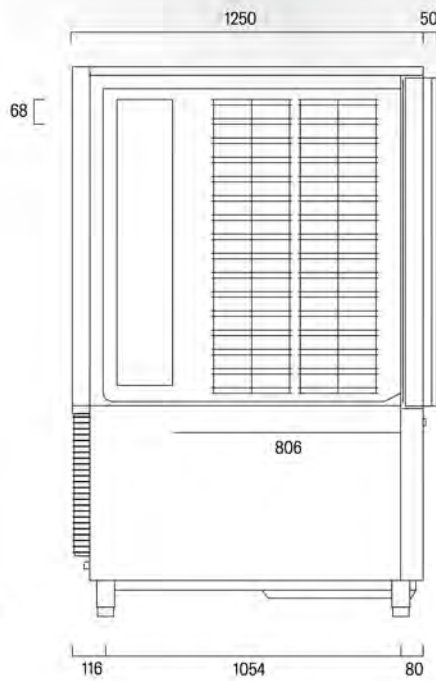
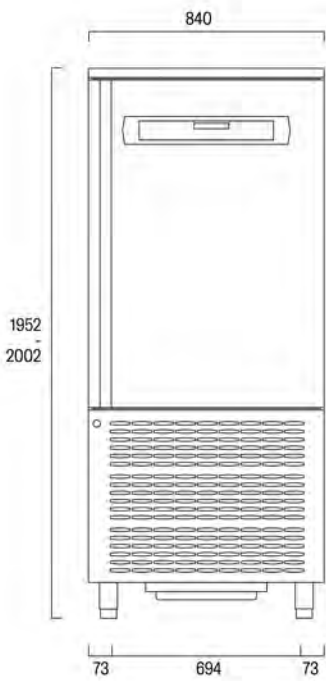







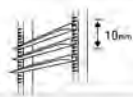

Capacity - Kapacitet	15 trays - 15 pladnjeva 15 trays - 15 pladnjeva	600 x 800 mm GN 2/1
Trays pitch - Prostor za pladnjeve		68 mm
Construction - Konstrukcija	Stainless steel - <i>Nehrđajući čelik</i> AISI 304	
Voltage - Napon	400 V / 3 N / 50 Hz	
Dimensions (WDH) - Dimenzije (Š x D x V)	840 x 1250 (1300) x 1952: 2002 mm	
Yield - Polje +90 °C → +3 °C	70 kg	
Yield - Polje +90 °C → -18 °C	55 kg	
Shipping data - Podaci za transport	Carton - <i>Kutija</i> 900 x 980 x 2160 mm – 260 kg	
Notes - Napomene	Reversible door - <i>Reverzibilna vrata</i> USB Drive included - <i>USB Disk uključen</i>	

Optionals - Opcije

■ **OPCIONALNO**

■ **RETROFIT**

<ul style="list-style-type: none"> ■ Castors kit ■ <i>Komplet kotača</i> 	
<ul style="list-style-type: none"> ■ Ozone Sanitization ■ <i>Čišćenje ozonom</i> 	
<ul style="list-style-type: none"> ■ Internal structure for pastry trays, with 15 pair of guide for variable pitch (10 mm) ■ <i>Unutarnja struktura za pladnjeve s pecivom, s 15 parova vodilica za varijabilni prostor (10 mm)</i> 	
<ul style="list-style-type: none"> ■ N. 1 pair of stainless steel guides for variable pitch structure (10 mm) ■ <i>Br. 1 par vodilica od nehrđajućeg čelika za varijabilnu strukturu prostora (10 mm)</i> 	
<ul style="list-style-type: none"> ■ Internal fittings for trays 460 x 660 mm ■ <i>Unutarnji utori za pladnjeve 460 x 660 mm</i> 	
<ul style="list-style-type: none"> ■ Water cooled condensing unit ■ <i>Kondenzacijska jedinica za hlađenu vodu</i> 	
<ul style="list-style-type: none"> ■ Remote condensing unit (installation kit 10 m) ■ <i>Daljinska kondenzacijska jedinica (instalacijski komplet 10 m)</i> 	
<ul style="list-style-type: none"> ■ <i>Seconde core probe</i> ■ <i>Druga sonda za mjerenje temperature u unutrašnjosti</i> 	

BT SERIJA

The machine - Uređaj

The multifunction blast chillers

Endless possibilities, one machine: BlueTOUCH Series is the new range of blast chillers including low temperature cooking and retarder proving functions, in addition to the best chilling/freezing options.

Multifunkcionalni brzi ohlađivači

Neograničene mogućnosti u jednom uređaju: BlueTOUCH serija je novi asortiman brzih ohlađivača koji uključuju funkcije kuhanja na niskoj temperaturi i vrenja, pored najboljih opcija za hlađenje/zamrzavanje.

Control panel - Upravljačka ploča

- Blast chilling cycle - *Ciklus brzog hlađenja*
- Shock freezing cycle - *Ciklus šok-zamrzavanja*
- Retarder proving cycle - *Ciklus vrenja*
- Thawing cycle - *Ciklus otapanja*
- Low T° cooking - *Kuhanje na niskoj temperaturi*
- Ice cream function - *Funkcija za sladoled*
- Conservation cycle - *Ciklus konzervacije*
- Programs library - *Memorija programa*



Features - Značajke

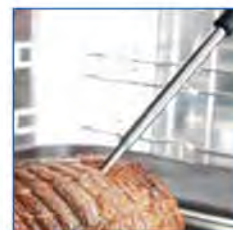

- Fan blades in composite resin
 - USB Drive
 - Deep-formed internal floor for easy cleaning
 - Core probe
 - Dual suitability trays rack
 - Cabinet in stainless steel AISI 304
 - Ice cream function
-
- *Lopatice ventilatora od kompozitne smole*
 - *USB priključak*
 - *Dubinski oblikovani unutarnji pod za jednostavno čišćenje*
 - *Sonda za mjerenje temperature u unutrašnjosti*
 - *Dvostruki ormar s pladnjevima*
 - *Ormar od nehrđajućeg čelika AISI 304*
 - *Funkcija za sladoled*

The models - Modeli

BC 10.35
 BC 15.65
 BC 15-2.70

BT 10

BT 10.35

BT 10.35 P (only for pastry trays - samo za pladnjeve s pecivima)

Blast Chillers - Brzi ohlađivači

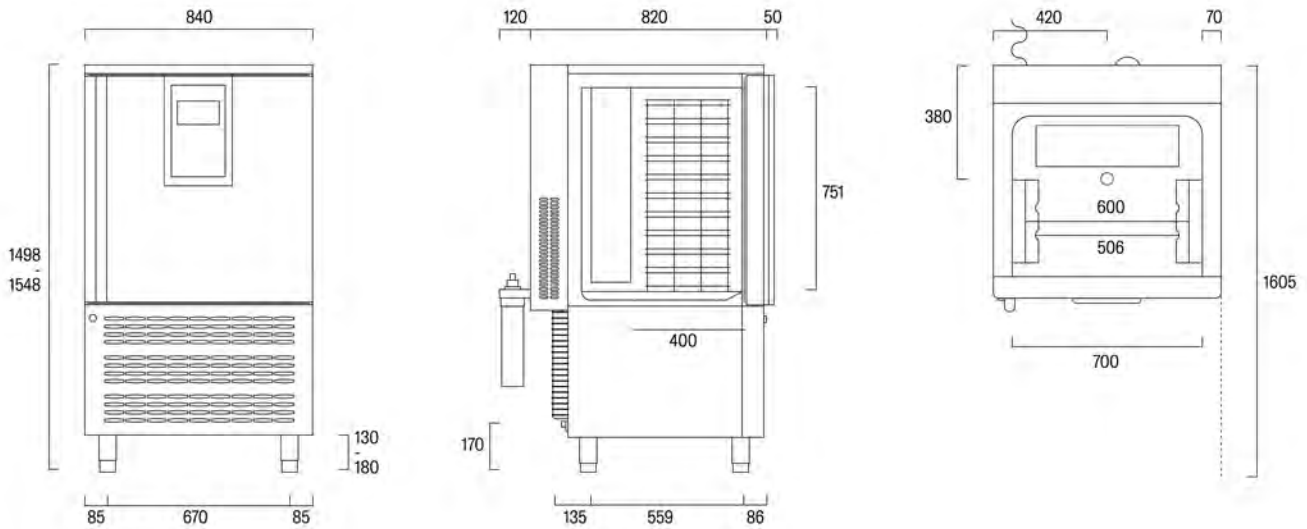



Capacity - Kapacitet	10 trays - 10 pladnjeva	600 x 400 mm
	10 trays - 10 pladnjeva	GN 1/1
Construction - Konstrukcija	Stainless steel - <i>Nehrđajući čelik</i> AISI 304	
Voltage - Napon	400 V / 3 N / 50 Hz	
Internal useful dimensions (WDH) - <i>Unutarnje iskoristive dimenzije (Š x D x V)</i>	700 x 400 x 745 mm	
Dimensions (WDH) - <i>Dimenzije (Š x D x V)</i>	840 x 871 x 1498: 1548 mm	
Yield - <i>Polje</i> +90 °C → +3 °C	35 kg	
Yield - <i>Polje</i> +90 °C → -18 °C	25 kg	
Shipping data - <i>Podaci za transport</i>	Carton - <i>Kutija</i> 880 x 940 x 1655 mm – 206 kg	
Notes - <i>Napomene</i>	Reversible door - <i>Reverzibilna vrata</i> USB Drive included - <i>USB priključak uključen</i>	

Optionals - Opcije

■ **OPCIONALNO**

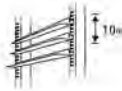
■ **RETROFIT**

<ul style="list-style-type: none"> ■ Castors kit ■ <i>Komplet kotača</i> 	
<ul style="list-style-type: none"> ■ Possibility to be remote controlled ■ <i>Mogućnost daljinskog upravljanja</i> 	
<ul style="list-style-type: none"> ■ Ozone Sanitization ■ <i>Čišćenje ozonom</i> 	
<ul style="list-style-type: none"> ■ Internal structure for pastry trays, variable pitch (10 mm) ■ <i>Unutarnja struktura za pladnjeve s pecivom, varijabilni prostor (10 mm)</i> 	
<ul style="list-style-type: none"> ■ N. 1 pair of stainless steel guides for variable pitch structure (10 mm) ■ <i>Br. 1 par vodilica od nehrđajućeg čelika za varijabilnu strukturu prostora (10 mm)</i> 	
<ul style="list-style-type: none"> ■ Water cooled condensing unit ■ <i>Kondenzacijska jedinica za hlađenu vodu</i> 	
<ul style="list-style-type: none"> ■ Seconde core probe ■ <i>Druga sonda za mjerenje temperature u unutrašnjosti</i> 	

BT 15

BT 15.65

BT 15.65 P (only for pastry trays - samo za pladnjeve s pecivima)

Blast Chillers - Brzi ohlađivači

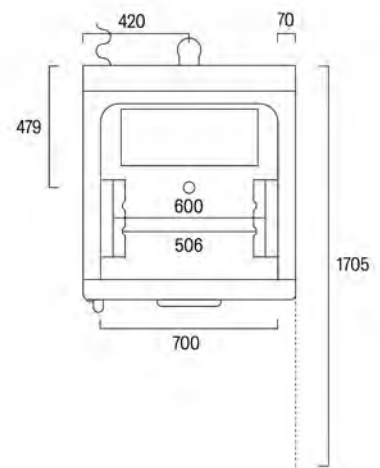
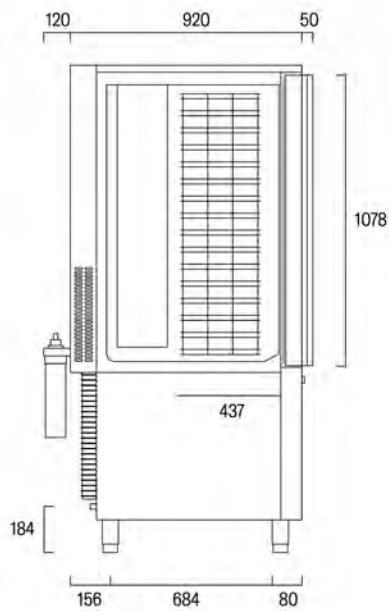
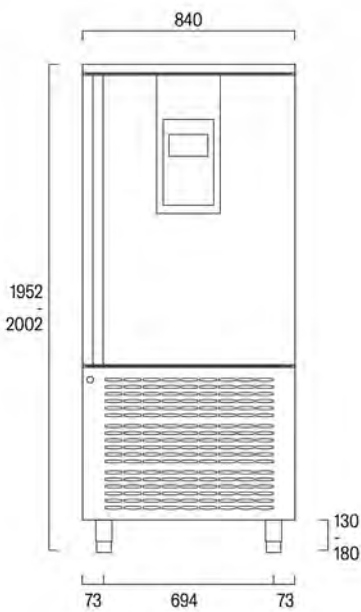







Capacity - Kapacitet	15 trays - 15 pladnjeva	600 x 400 mm
	15 trays - 15 pladnjeva	GN 1/1
Construction - Konstrukcija	Stainless steel - Nehrđajući čelik AISI 304	
Voltage - Napon	400 V / 3 N / 50 Hz	
Internal useful dimensions (WDH) - Unutarnje iskoristive dimenzije (Š x D x V)	700 x 430 x 1078 mm	
Dimensions (WDH) - Dimenzije (Š x D x V)	840 x 970 x 1952: 2002 mm	
Yield - Polje +90 °C → +3 °C	65 kg	
Yield - Polje +90 °C → -18 °C	50 kg	
Shipping data - Podaci za transport	Carton - Kutija 880 x 1040 x 2160 mm – 296 kg	
Notes - Napomene	Reversible door - Reverzibilna vrata USB Drive included - USB priključak uključen	

Optionals - Opcije

■ OPCIONALNO

■ RETROFIT

<ul style="list-style-type: none"> ■ Castors kit ■ Komplet kotača 	
<ul style="list-style-type: none"> ■ Possibility to be remote controlled Mogućnost daljinskog upravljanja 	
<ul style="list-style-type: none"> ■ Ozone Sanitization Čišćenje ozonom 	
<ul style="list-style-type: none"> ■ Internal structure for pastry trays, variable pitch (10 mm) ■ Unutarnja struktura za pladnjeve s pecivom, varijabilni prostor (10 mm) 	
<ul style="list-style-type: none"> ■ N. 1 pair of stainless steel guides for variable pitch structure (10 mm) ■ Br. 1 par vodilica od nehrđajućeg čelika za varijabilnu strukturu prostora (10 mm) 	
<ul style="list-style-type: none"> ■ Water cooled condensing unit Kondenzacijska jedinica za hlađenu vodu 	
<ul style="list-style-type: none"> ■ Seconde core probe Druga sonda za mjerenje temperature u unutrašnjosti 	

BT 15-2.70

BT 15-2.70

BT 15-2.70 P (only for pastry trays - samo za pladnjeve s pecivima)

Blast Chillers - Brzi ohlađivači

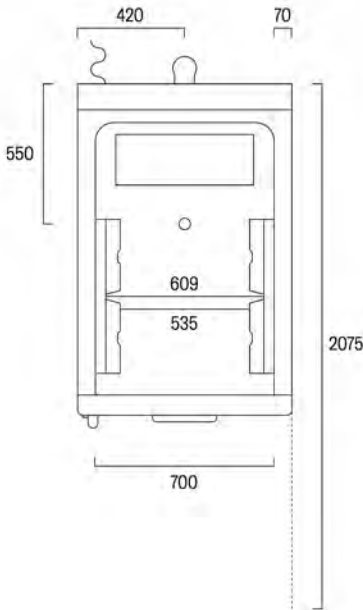
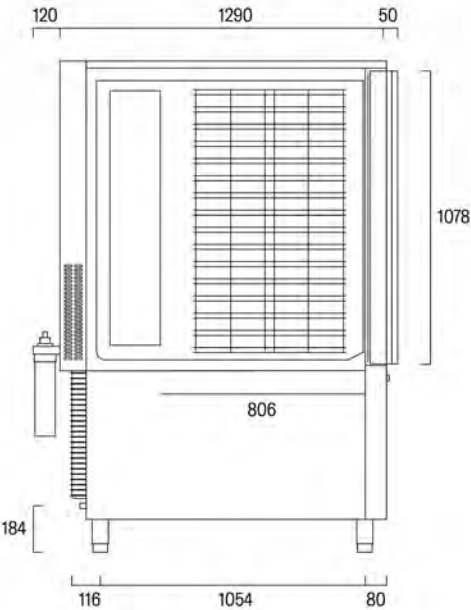
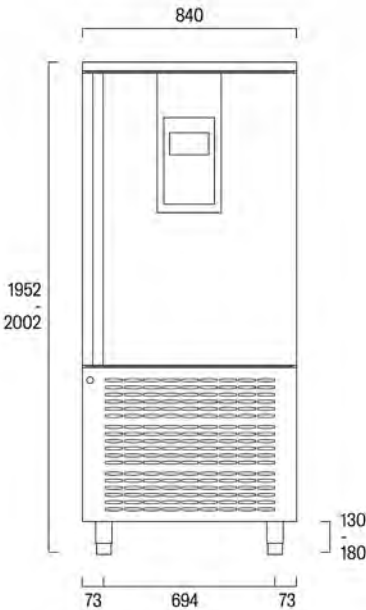

Capacity - Kapacitet	30 trays - 30 pladnjeva 600 x 400 mm
	30 trays - 30 pladnjeva GN 1/1
Construction - Konstrukcija	Stainless steel - Nehrđajući čelik AISI 304
Voltage - Napon	400 V / 3 N / 50 Hz
Internal useful dimensions (WDH) - Unutarnje iskoristive dimenzije (Š x D x V)	700 x 805 x 1075 mm
Dimensions (WDH) - Dimenzije (Š x D x V)	840 x 1340 x 1952: 2002 mm
Yield - Polje +90 °C → +3 °C	70 kg
Yield - Polje +90 °C → -18 °C	55 kg
Shipping data - Podaci za transport	Carton - Kutija 880 x 1400 x 2160 mm – 304 kg
Notes - Napomene	Reversible door - Reverzibilna vrata USB Drive included - USB priključak uključen

Optionals - Opcije

■ OPCIONALNO

■ RETROFIT

- Castors kit
- Komplet kotača



- Possibility to be remote controlled
- Mogućnost daljinskog upravljanja



- Ozone Sanitization
- Čišćenje ozonom



- Internal structure for pastry trays, variable pitch (10 mm)
- Unutarnja struktura za pladnjeve s pecivom, varijabilni prostor (10 mm)



- N. 1 pair of stainless steel guides for variable pitch structure (10 mm)
- Br. 1 par vodilica od nehrđajućeg čelika za varijabilnu strukturu prostora (10 mm)



- Water cooled condensing unit
- Kondenzacijska jedinica za hlađenu vodu



- Seconde core probe
- Druga sonda za mjerenje temperature u unutrašnjosti



The machine - Uređaj

Quality and power in one machine

Trolley blast chillers designed to satisfy the needs of industrial and handmade food sector users. The Blue TOUCH series: experience and reliability at the top of the table.

Kvaliteta i snaga u jednom uređaju

Brzi ohlađivači za kolicima dizajnirani su kako bi ispunili sve industrijske i kućanske potrebe korisnika iz prehrambenog sektora. Blue TOUCH serija: iskustvo i pouzdanost na vrhuncu.

Control panel - Upravljačka ploča

- Blast chilling cycle - *Ciklus brzog hlađenja*
- Shock freezing cycle - *Ciklus šok-zamrzavanja*
- Thawing cycle - *Ciklus otapanja*
- Ice cream function - *Funkcija za sladoled*
- Conservation cycle - *Ciklus konzervacije*
- Programs library - *Memorija programa*



Features - Značajke



- Fan blades in composite resin
 - Deep-formed internal floor for easy cleaning
 - Core probe
 - Insulated floor with external ramp
 - Right hinged door
 - USB Drive
 - Remote condensing unit with 10 mt installation kit (except BT 20.80)
-
- *Lopatice ventilatora od kompozitne smole*
 - *Dubinski oblikovani unutarnji pod za jednostavno čišćenje*
 - *Sonda za mjerenje temperature u unutrašnjosti*
 - *Izolirani pod s vanjskom rampom*
 - *Vrata sa šarkama na desnoj strani*
 - *USB priključak*
 - *Daljinska kondenzacijska jedinica s 10 m instalacijskim kompletom*
(osim BT 20.80)

The models - Modeli

BT 20
BT 30
BT 40
BT 50

BT 20

BT 20.80 (integrated condensing unit - *integrirana kondenzacijska jedinica*)

BT 20.80 RE (remote condensing unit - *daljinska kondenzacijska jedinica*)

BT 20.110 RE (remote condensing unit - *daljinska kondenzacijska jedinica*)

Blast Chillers - Brzi ohlađivači

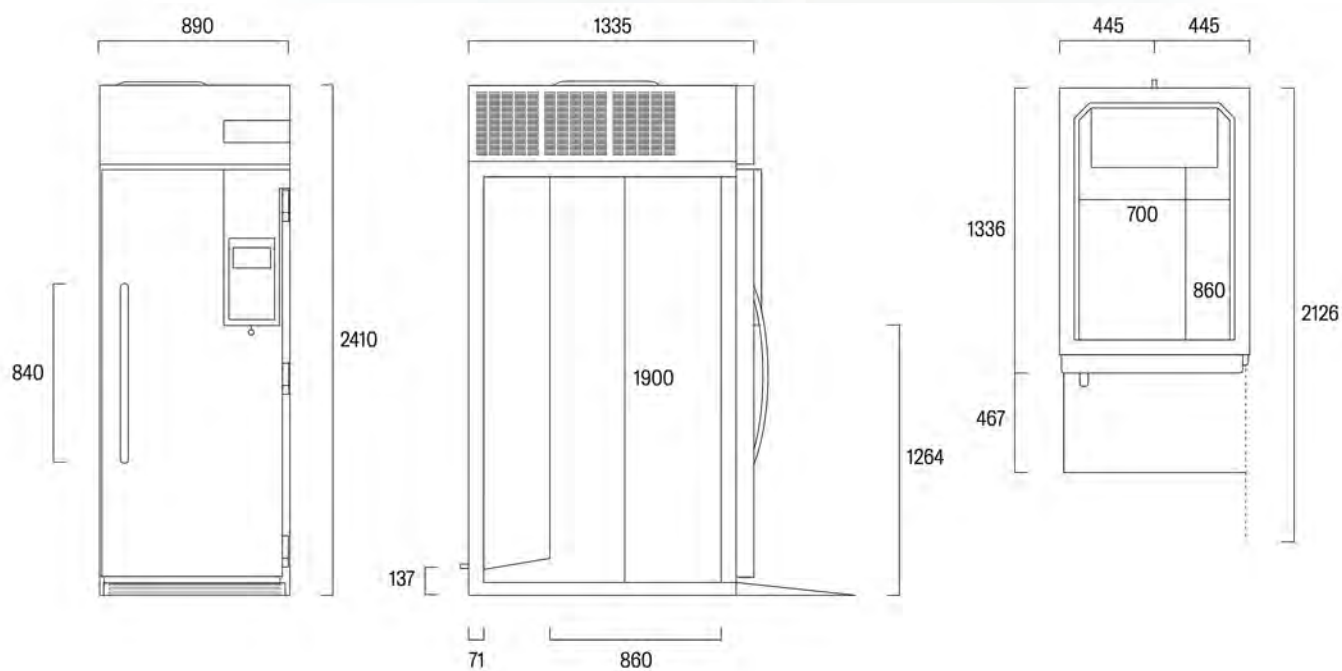







Capacity - Kapacitet	1 trolley - 1 kolica	GN 1/1
	1 trolley - 1 kolica	GN 2/1
	1 trolley - 1 kolica	600 x 800 mm
Construction - Konstrukcija	Stainless steel - <i>Nehrđajući čelik</i> AISI 304	
Voltage - Napon	400 V / 3 N / 50 Hz	
Internal useful dimensions (WDH) - <i>Unutarnje iskoristive dimenzije (Š x D x V)</i>	680 x 870 x 1850 mm	
Dimensions (WDH) - <i>Dimenzije (Š x D x V)</i>	890 x 1371 x 2410 mm	
Yield - <i>Polje +90 °C → +3 °C</i>	BT 20.80 – BT 20.80 RE	80 kg
	BT 20.110 RE	110 kg
Yield - <i>Polje +90 °C → -18 °C</i>	BT 20.80 – BT 20.80 RE	65 kg
	BT 20.110 RE	95 kg
Shipping data - <i>Podaci za transport</i>	BT 20.80	Wood cage - <i>Drveni kavez</i> 1000 x 1560 x 2550 mm – 430 kg
	BT 20.80 RE – BT 20.110 RE	Wood cage - <i>Drveni kavez</i> 1000 x 1560 x 2550 mm – 332 kg
	BT 20.80 RE – BT 20.110 RE	Carton - <i>Kutija 3/4 KS</i> 1100 x 1700 x 700 mm – 170 kg
Notes - <i>Napomene</i>	Insulated floor h 60 mm with external ramp - <i>Izolirani pod visine 60 mm s vanjskom rampom</i>	
	Trolley not supplied - <i>Kolica nisu uključena</i>	
	Left hinged door on request - <i>Vrata sa šarkama na lijevoj strani isporučiva na zahtjev</i>	
	Monocoque version - <i>Monokok izvedba</i> Remote controlled - <i>Daljinsko upravljanje</i> USB Drive included - <i>USB priključak uključen</i>	

Optionals - Opcije

■ OPCIONALNO

■ RETROFIT

Ozone Sanitization <i>Čišćenje ozonom</i>	
Version without condensing unit <i>Verzija s kondenzacijskom jedinicom</i>	
Additional installation kit <i>Dodatni instalacijski komplet</i>	
Disassembled panels <i>Rastavljeni paneli</i>	
Seconde core probe <i>Druga sonda za mjerenje temperature u unutrašnjosti</i>	
Supplement for condensing unit case <i>Dodatak za kućište s kondenzacijskom jedinicom</i>	

BT 30

BT 30/110

BT 30/140

Blast Chillers - Brzi ohlađivači

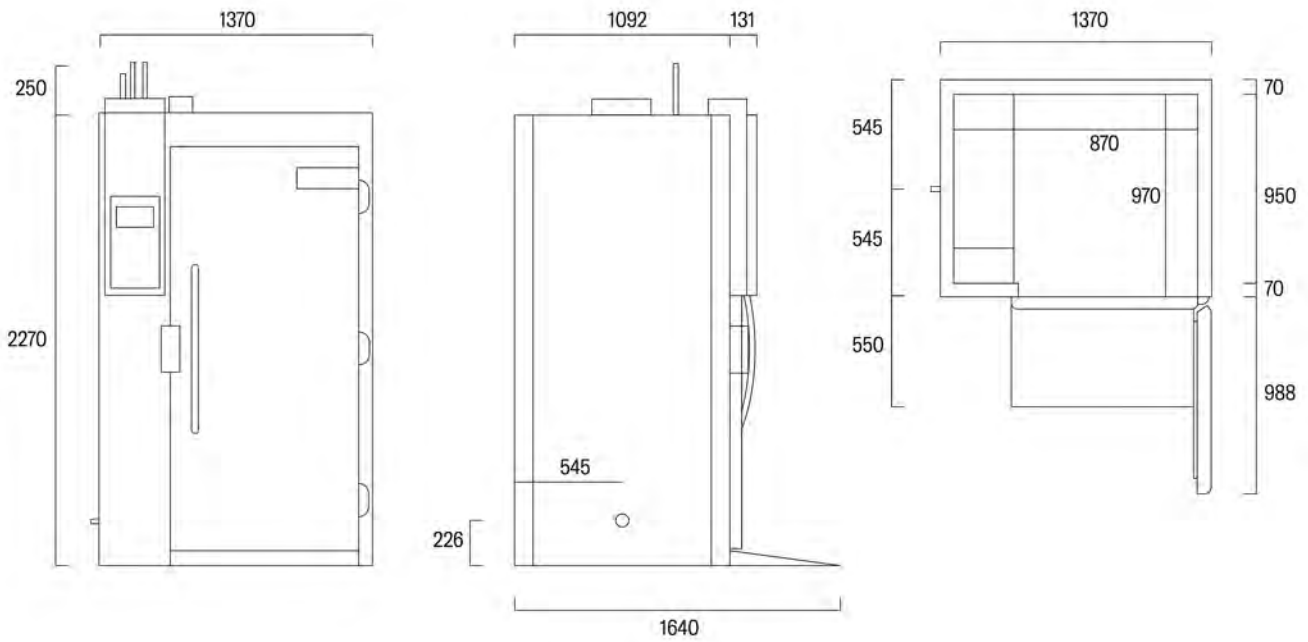







Capacity - Kapacitet	1 trolley - 1 kolica		GN 2/1
	1 trolley - 1 kolica		600 x 800 mm
Power - Snaga	BT 30/110		4 KS
	BT 30/140		5,5 KS
Construction - Konstrukcija	Stainless steel - <i>Nehrđajući čelik</i> AISI 304		
Voltage - Napon	400 V / 3 N / 50 Hz		
Internal useful dimensions (WDH) - <i>Unutarnje iskoristive dimenzije (Š x D x V)</i>	860 x 920 x 2000 mm		
Dimensions (WDH) - <i>Dimenzije (Š x D x V)</i>	1370 x 1210 x 2274 mm		
Yield - <i>Polje +90 °C → +3 °C</i>	BT 30/110	110 kg	
	BT 30/140	140 kg	
Yield - <i>Polje +90 °C → -18 °C</i>	BT 30/110	95 kg	
	BT 30/140	125 kg	
Shipping data - <i>Podaci za transport</i>	<small>panels+evaporator - paneli + isparivač</small>	Wood cage - <i>Drveni kavez</i>	2500 x 1460 x 1120 mm – 450 kg
	BT 30/110	Carton - <i>Kutija</i>	700 x 800 x 1550 mm – 270 kg
	BT 30/140	Carton - <i>Kutija</i>	1580 x 960 x 840 mm – 310 kg
Notes - <i>Napomene</i>	<p>Installation kit up to 10 mt included - <i>Instalacijski komplet do 10 m je uključen</i> The machine is delivered disassembled - <i>Stroj se isporučuje rastavljen</i> Insulated floor h 70 mm with external ramp - <i>Izolirani pod visine 70 mm s vanjskom rampom</i> Trolley not supplied - <i>Kolica nisu uključena</i> Remote controlled - <i>Daljinsko upravljanje</i> USB Drive included - <i>USB priključak uključen</i></p>		

Optionals - Opcije

■ **OPCIONALNO**

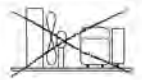
■ **RETROFIT**

Ozone Sanitization <i>Čišćenje ozonom</i>	
Water cooled condensing unit <i>Kondenzacijska jedinica za hladenu vodu</i>	
Supplement for low noise condensing unit with sound-absorbent case <i>Dodatak za tihu kondenzacijsku jedinicu s kućištem za prigušenje zvuka</i>	
Additional installation kit <i>Dodatni instalacijski komplet</i>	
Version without condensing unit <i>Verzija s kondenzacijskom jedinicom</i>	
Additional door (tunnel) <i>Dodatni vrata (tunel)</i>	
Seconde core probe <i>Druga sonda za mjerenje temperature u unutrašnjosti</i>	

BT 40

BT 40/150

BT 40/200

Blast Chillers - Brzi ohlađivači

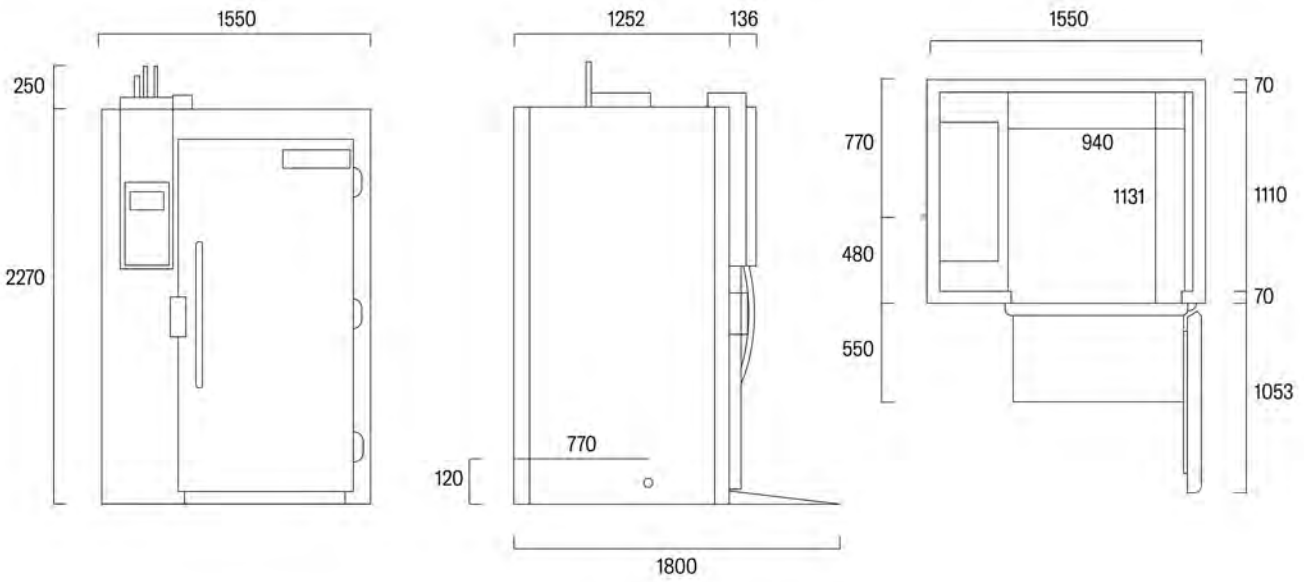







Capacity - Kapacitet	1 trolley - 1 kolica	GN 2/1
	1 trolley - 1 kolica	800 x 1000 mm
Power - Snaga		BT 40/150 5,5 KS
		BT 40/200 7,5 KS
Construction - Konstrukcija	Stainless steel - <i>Nehrđajući čelik</i> AISI 304	
Voltage - Napon	cabinet - <i>ormar</i>	400 V / 3 N / 50 Hz
	condensing unit - <i>kondenzacijska jedinica</i>	400 V / 3 N / 50 Hz
Dimensions (WDH) - Dimenzije (Š x D x V)	1550 x 1370 x 2470 mm	
Yield - Polje +90 °C → +3 °C	BT 40/150	150 kg
	BT 40/200	200 kg
Yield - Polje +90 °C → -18 °C	BT 40/150	135 kg
	BT 40/200	175 kg
Shipping data - Podaci za transport	panels+evaporator - <i>paneli + isparivač</i>	Wood cage - <i>Drveni kavez</i> 2500 x 1650 x 1440 mm – 580 kg
	BT 40/150	Carton - <i>Kutija</i> 1580 x 960 x 840 mm – 310 kg
	BT 40/200	Carton - <i>Kutija</i> 1580 x 960 x 840 mm – 320 kg
Notes - Napomene	Installation kit up to 10 mt included - <i>Instalacijski komplet do 10 m je uključen</i> The machine is delivered disassembled - <i>Stroj se isporučuje rastavljen</i> Insulated floor h 70 mm with external ramp - <i>Izolirani pod visine 70 mm s vanjskom rampom</i> Trolley not supplied - <i>Kolica nisu uključena</i> Remote controlled - <i>Daljinsko upravljanje</i> USB Drive included - <i>USB priključak uključen</i>	

Optionals - Opcije

■ OPCIONALNO

■ RETROFIT

Ozone Sanitization <i>Čišćenje ozonom</i>	
Water cooled condensing unit <i>Kondenzacijska jedinica za hladenu vodu</i>	
Supplement for low noise condensing unit with sound-absorbent case <i>Dodatak za tihu kondenzacijsku jedinicu s kućištem za prigušenje zvuka</i>	
Additional installation kit <i>Dodatni instalacijski komplet</i>	
Version without condensing unit <i>Verzija s kondenzacijskom jedinicom</i>	
Additional door (tunnel) <i>Dodatni vrata (tunel)</i>	
Seconde core probe <i>Druga sonda za mjerenje temperature u unutrašnjosti</i>	

BT 50

BT 50/270

BT 50/400

Blast Chillers - Brzi ohlađivači

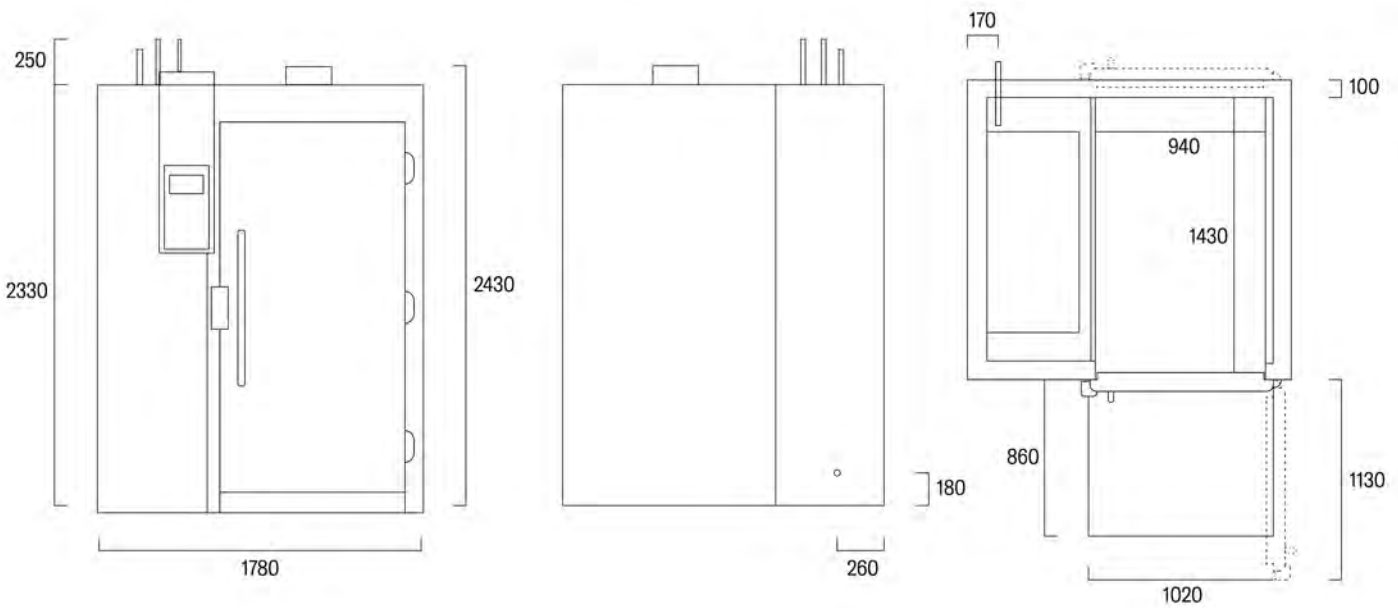

Capacity - Kapacitet	2 trolley - 2 kolica	GN 2/1
	2 trolley - 2 kolica	600 x 800 mm
Power - Snaga	BT 50/270	10 KS
	BT 50/400	15 KS
Construction - Konstrukcija	Stainless steel - <i>Nehrđajući čelik</i> AISI 304	
Voltage - Napon	cabinet - <i>ormar</i>	400 V / 3 N / 50 Hz
	condensing unit - <i>kondenzacijska jedinica</i>	400 V / 3 N / 50 Hz
Internal useful dimensions (WDH) - <i>Unutarnje iskoristive dimenzije (Š x D x V)</i>	1580 x 1430 x 2000 mm	
Dimensions (WDH) - <i>Dimenzije (Š x D x V)</i>	1780 x 1790 x 2330 mm	
Yield - <i>Polje +90 °C → +3 °C</i>	BT 50/270	270 kg
	BT 50/400	390 kg
Yield - <i>Polje +90 °C → -18 °C</i>	BT 50/270	250 kg
	BT 50/400	365 kg







Shipping data - <i>Podaci za transport</i>	panels+evaporator - <i>paneli + isparivač</i>	Wood box - <i>Drveni kavez</i>	2460 x 1750 x 1320 mm – 770 kg
	evaporator - <i>isparivač</i>	Carton - <i>Kutija</i>	2200 x 1210 x 850 mm – 230 kg
	BT 50/270	Carton - <i>Kutija</i>	2450 x 1350 x 1450 mm – 580 kg
	BT 50/400	Carton - <i>Kutija</i>	2450 x 1350 x 1450 mm – 690 kg

Installation kit up to 10 mt included - *Instalacijski komplet do 10 m je uključen*
 The machine is delivered disassembled - *Stroj se isporučuje rastavljen*
 Insulated floor h 100 mm with external ramp - *Izolirani pod visine 100 mm s vanjskom rampom*
 Trolley not supplied - *Kolica nisu uključena*
 Remote controlled - *Daljinsko upravljanje*
 USB Drive included - *USB priključak uključen*

Optionals - Opcije

■ **OPCIONALNO**

■ **RETROFIT**

Ozone Sanitization <i>Čišćenje ozonom</i>	
Water cooled condensing unit <i>Kondenzacijska jedinica za hladenu vodu</i>	
Supplement for low noise condensing unit with sound-absorbent case <i>Dodatak za tihu kondenzacijsku jedinicu s kućištem za prigušenje zvuka</i>	Price on request <i>Cijena na zahtjev</i> 
Additional installation kit <i>Dodatni instalacijski komplet</i>	
Version without condensing unit <i>Verzija s kondenzacijskom jedinicom</i>	
Additional door (tunnel) <i>Dodatni vrata (tunel)</i>	
Seconde core probe <i>Druga sonda za mjerenje temperature u unutrašnjosti</i>	

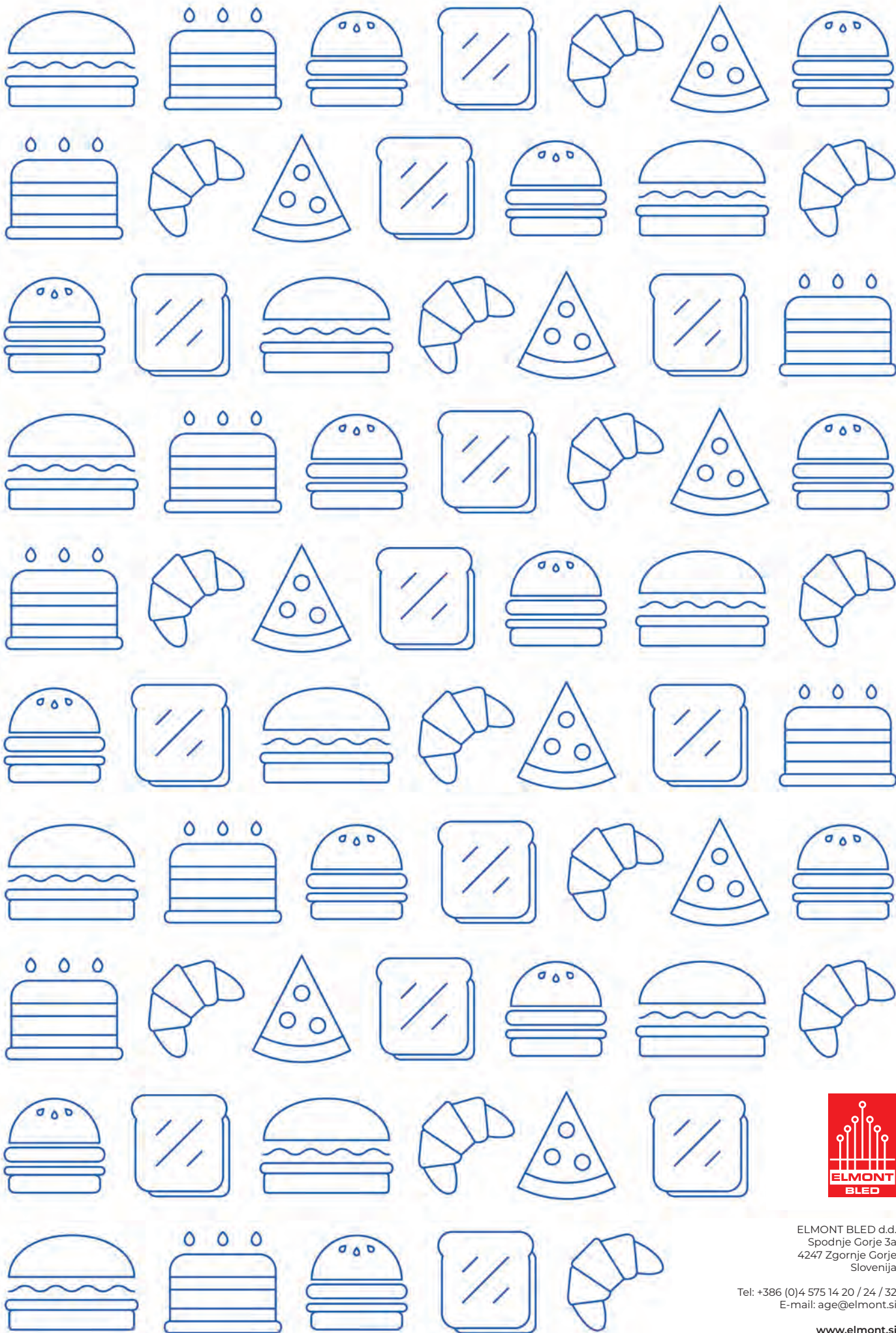

ELMONT BLED d.d.
Spodnje Gorje 3a
4247 Zgornje Gorje
Slovenija

Tel: +386 (0)4 575 14 20 / 24 / 32
E-mail: age@elmont.si

www.elmont.si